

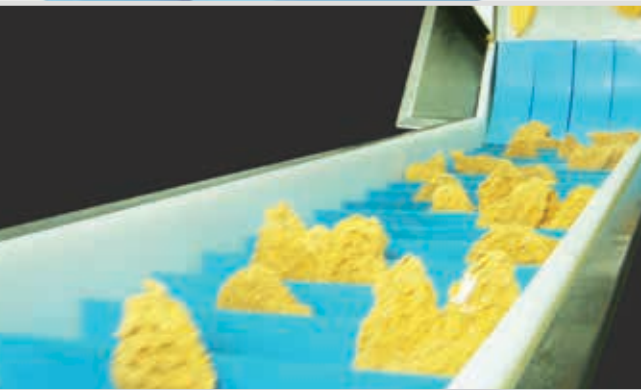

**VOLTA
BELTING**
Technology

.....
DualDrive™

Technical Manual

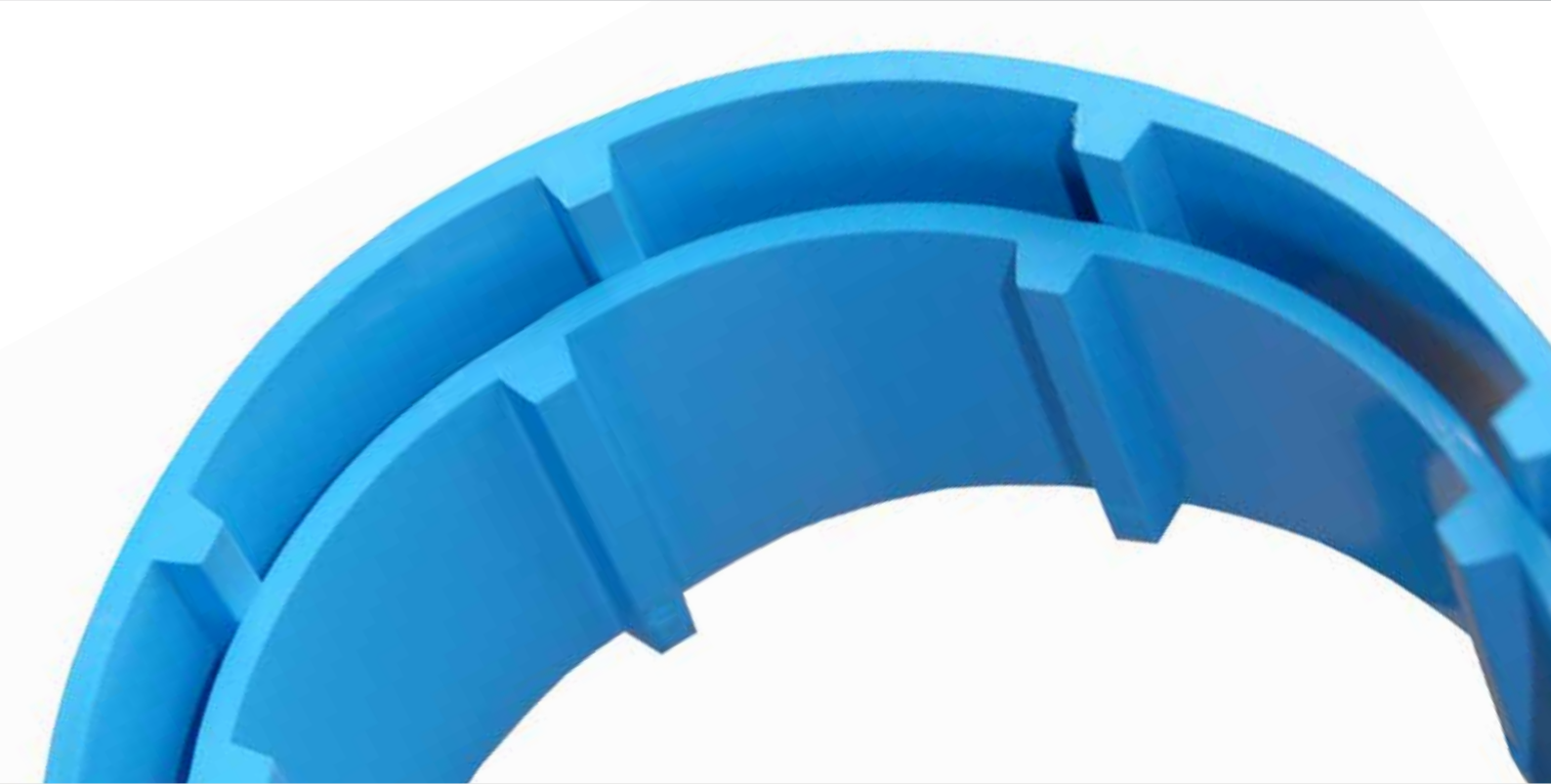

The Next Step in Belting

Table of Contents	Page
1. Introduction	3
2. Technical Data	4
Volta 'M' Material DualDrive™ Belts & Fabrication Guidelines.....	4-5
Volta 'LT' Low Temperature Material DualDrive™ Belts & Fabrication Guidelines.....	6-7
Volta 'MD' Metal Detectable Material DualDrive™ Belts & Fabrications	8-9
Volta 'H' Material DualDrive™ Belts & Fabrication Guidelines	10-11
3. Accessories	12
Sprockets, DualDrive™ Sprocket Types.....	12
Sprocket Spacing.....	12
Sprocket Bore Description.....	12
Securing DualDrive™ Sprockets : Locking Collars.....	13
Motorized Pulley	13
4. Conveyor Construction	14
Classic Conveyor Construction.....	14
Conveyor Construction Guidelines.....	14
Take-up Device (Tensioner).....	15
Return-Ways	15
Snub Rollers	16
Containment of DualDrive™ Belts.....	16
“Z” or Swanneck Conveyor Construction.....	17
Centre Drive Conveyor.....	17
Removing Belt for Cleaning.....	18
5. Splicing the DualDrive	19
FBW Flat Butt Welding Tool.....	19
FT-Electrode Welding Tool.....	19
Plastic Hinge Lace	20
6. Belt Calculations	21
Pull Force Calculation Procedure.....	22-23
7. Motor Capacity Calculation	24
8. Notes	25-27

1. Introduction

DualDrive™ is a fully extruded positive drive belt featuring a smooth homogeneous character and integral teeth on the drive side which can act as built-in cleats.

- ➔ When improved hygiene standards are needed, the DualDrive belt is ideal for replacing existing modular belts.
- ➔ DualDrive™ "M" material has a 2" pitch suited to some models of modular sprockets. Changing such a belt requires a minimal retrofit and new Volta sprockets are recommended in all cases.

Material Features

- Smooth homogeneous surface.
- Impression top textures are available for special applications (e.g. non-stick).
- No ply or fraying edges. No finger splicing and delamination.
- No cracks or crevices that harbor bacteria. The material enables lower bacteria counts and longer product shelf life.
- Easy and effective cleaning, reducing downtime and water consumption to a minimum.

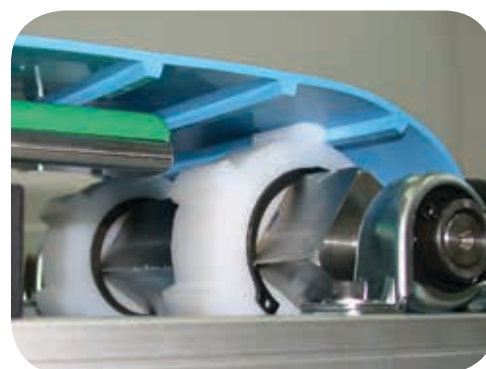

DualDrive™ positive drive belts lower your water consumption, maintenance and sanitation costs while drastically boosting your production hygiene level.

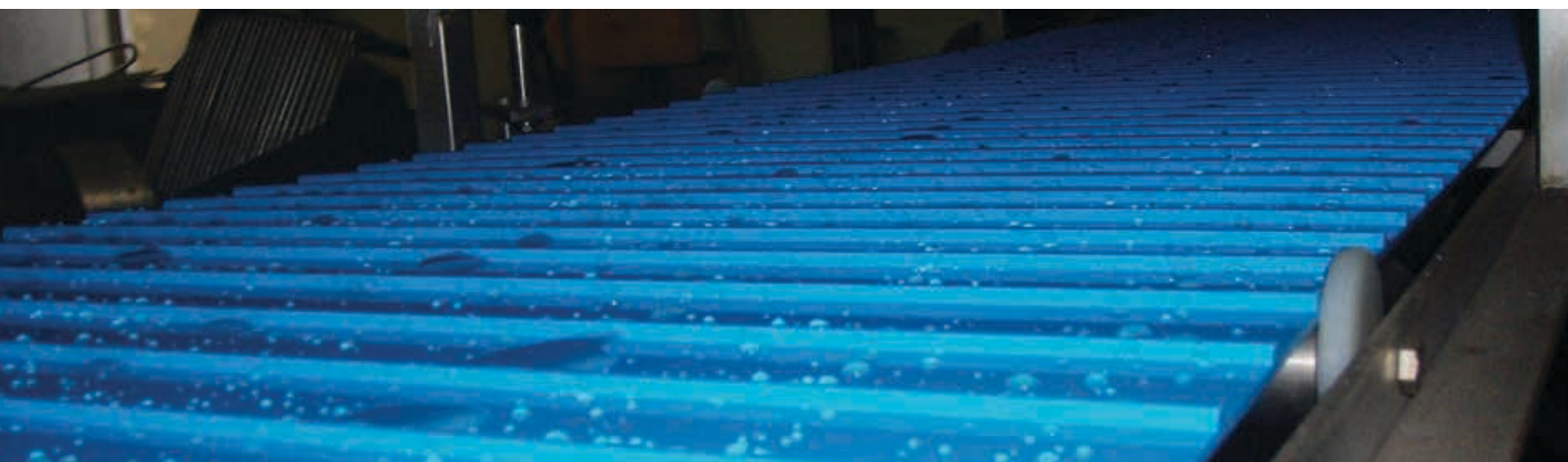

Mechanical Benefits

- Eliminates modular components that require extensive cleaning and lengthy soaking.
- Greatly reduces noise levels when compared to modular belting.
- Integrated teeth prevent slippage of the belt.
- No belt pretension needed, avoiding elongation and increasing belt life.
- Volta's Plastic Hinge Lace allows for ease of belt removal for cleaning or conveyor maintenance.
- Extruded in 30 or 60m (100 or 200 ft.) lengths and 1524mm (60") width.

2. Technical Data

Volta 'M' Material DualDrive™ Belts

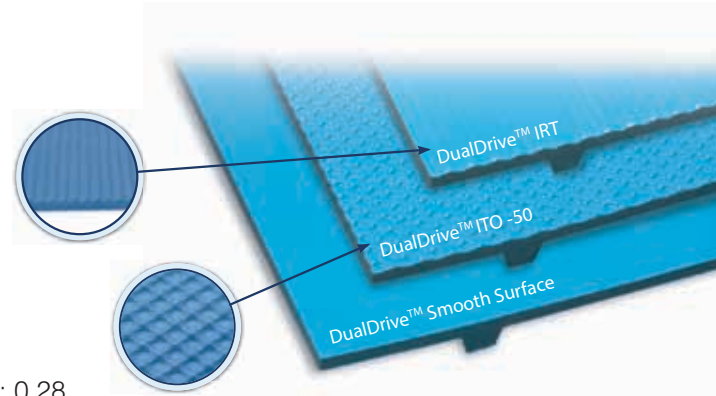

- ➔ **Material:** Volta MW, Beige / Volta MB, Blue
- ➔ **Shore Hardness:** 53D
- ➔ **Temperature Range :** -20° C to 60° C / -5° F to 140° F
- ➔ **Coefficient of Friction:** Steel: 0.5 /Stainless Steel: 0.5 /UHMW: 0.28
- ➔ **Certification:** FDA/ USDA/ USDA Dairy/ EU Approved

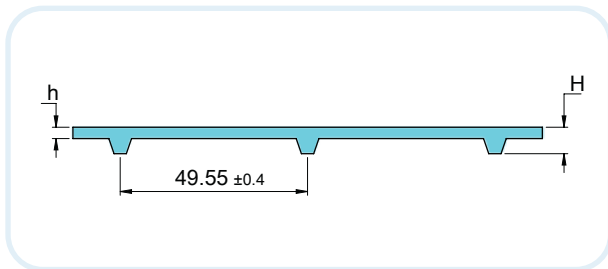

DualDrive™

***h**= Belt Thickness, **H** = Belt Thickness + 4.3mm
Pitch Between Teeth : 49.55 ± 0.4mm
Standard Belt Width: 1524mm / 60"

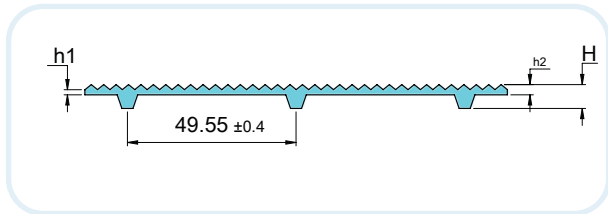

DualDrive™ ITO-50

***h**= Belt Thickness, **H** = Belt Thickness + 4.3mm
Pitch Between Teeth : 49.55 ± 0.4mm
Standard Belt Width: 1524mm / 60"

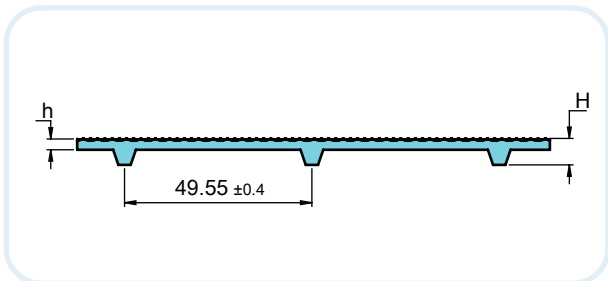

DualDrive™ IRT

***h1**= Belt Thickness, **h2** = Belt Thickness + 0.7mm
H = Belt Thickness + 4.3mm
Pitch Between Teeth : 49.55 ± 0.4mm
Standard Belt Width: 1524mm / 60"

Table 2.1

Product	FMB-3 DD/ FMW-3 DD	FMB-3 DD ITO - 50	FMB-4 DD	FMB-4 DD IRT
Belt Thickness*	h = 3, H = 7.3	h = 3, H = 7.3	h = 4, H = 8.3	h1 = 3, h2 = 3.7, H = 8
Belt weight (kg/ m ²)	4.5 kg/ m ²	4.2 kg/ m ²	5.7 kg/ m ²	4.6 kg/ m ²
Belt weight (lb/ ft ²)	0.92 lb/ ft ²	0.86 lb/ ft ²	1.16 lb/ ft ²	0.94 lb/ ft ²
Minimum sprocket diameter (normal flex)*	80 mm/ 3¼"		120 mm/ 4¾"	100 mm/ 4"
Minimum sprocket diameter (back flex)*	100 mm/ 4"		140 mm/ 5½"	120 mm/ 4¾"
Max pull force (kg/cm width)	6		7.7	6
Max pull force (lb/in. width)	33.6		43	33.6

Note: This belt can also be driven on existing modular belt sprocket sizes:
 • 8 teeth, 5.2" / 132mm • 10 teeth, 6.5" / 165mm

Sprocket Guidelines & Fabrication Options

Table 2.2

Belt Type	FMW-3 DD / FMB-3 DD				FMB-4 DD				
MPD Base Belt	80mm		3¼"		120mm		4¾"		
Minimum Sprocket Diameter for V-Flights									
Electrode	120mm		4.72"		150mm		5.90"		
VLC / VLB 10	130mm		5.12"		170mm		6.70"		
VLC / VLB 13	140mm		5.51"		180mm		7.08"		
VLC / VLB 17	155mm		6.10"		195mm		7.68"		
Minimum Sprocket Diameter for Flat Electrode Welded Flights									
Single Electrode 7	125mm		4.92"		150mm		5.90"		
Single Electrode 9	140mm		5.51"		165mm		6.50"		
Double Electrode 7	165mm		6.50"		190mm		7.48"		
Double Electrode 9	NR				NR				
Minimum Sprocket Diameter for Flat High Frequency Welded Flights									
App. Temperature	Temp ≥ 0° C / 32° F		Temp < 0° C / 32° F		Temp ≥ 0° C / 32° F		Temp < 0° C / 32° F		
Flight 3 - 5 mm	101mm	3.97"	151mm	5.94"	128mm	5.04"	180mm	7.09"	
Flight 6 - 8 mm	128mm	5.04"	180mm	7.09"	143mm	5.63"	200mm	7.87"	
Minimum Sprocket Diameter for Based Sidewalls - Normal Flex									
SW-20	130mm		5.12"		145mm		5.70"		
SW-30	130mm		5.12"		145mm		5.70"		
SW-40	130mm		5.12"		145mm		5.70"		
SW-50	130mm		5.12"		145mm		5.70"		
SW-60	130mm		5.12"		145mm		5.70"		
SW-80	155mm		6.10"		155mm		6.10"		
SW-100	210mm		8.27"		210mm		8.27"		
Minimum Sprocket Diameter for Baseless Sidewalls									
		Normal Flex		Back Flex		Normal Flex		Back Flex	
B-SW 30mm/ 1"	1.6mm Thick	80mm	3.15"	110mm	4.33"	120mm	4.72"	140mm	5.51"
B-SW 40 mm/ 1.5"		90mm	3.54"	120mm	4.72"	120mm	4.72"	140mm	5.51"
B-SW 50 mm/ 2"		100mm	3.94"	150mm	5.90"	120mm	4.72"	160mm	6.30"
B-SW 60 mm/ 2.5"		110mm	4.33"	180mm	7.10"	120mm	4.72"	190mm	7.50"
B-SW 80 mm/ 3"		130mm	5.12"	230mm	9.05"	130mm	5.12"	240mm	9.45"
B-SW 100 mm/ 4"		160mm	6.30"	300mm	11.81"	160mm	6.30"	310mm	12.2"
B-SW 130 mm/ 5"	2mm Thick	210mm	8.27"	400mm	15.75"	210mm	8.27"	420mm	16.53"
B-SW 150 mm/ 6"		250mm	9.84"	450mm	17.72"	250mm	9.84"	470mm	18.50"

Note: NR-Not Recommended.

All inch sizes have been converted from metric sizes.

- ➔ **Electrode welded Flights:** we recommend welding the flights above the teeth location and cleat thickness should not exceed the tooth base width.
- ➔ **Flights:** can be welded on top of a tooth but they must not exceed the width of the tooth or between teeth, but not in the area where sprocket teeth make contact with the belt when driving it. (see page 9)
- ➔ When choosing the sprocket size, it must be equal to or larger than the minimum pulley required.

Volta 'LT' Low Temperature Material DualDrive™ Belt

- ➔ **Material:** Volta MB LT, Blue
- ➔ **Shore Hardness:** 95A/ 46D
- ➔ **Temperature Range :** -35° C to 35° C / -31° F to 95° F
- ➔ **Coefficient of Friction:** Steel: 0.55 /Stainless Steel: 0.55 /UHMW: 0.30
- ➔ **Certification:** FDA/ USDA/ USDA Dairy/ EU Approved

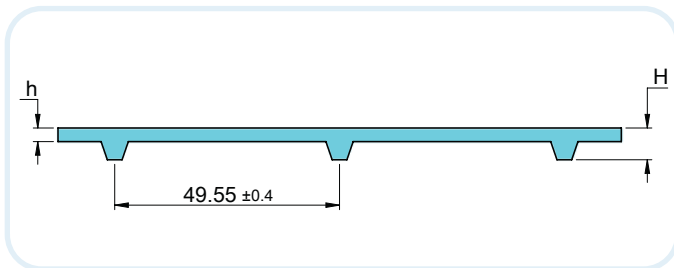
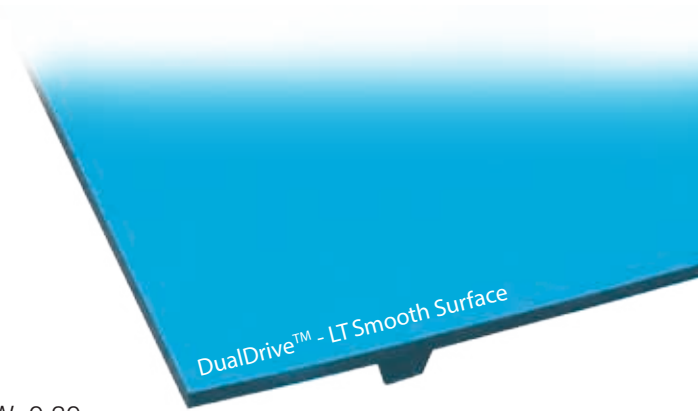

***h**= Belt Thickness, **H** = Belt Thickness + 4.3mm
Pitch Between Teeth : 49.55 ± 0.4mm
Standard Belt Width: 1524mm / 60"

Table 2.3

Product	FMB-3 DD LT
Belt Thickness*	h = 3, H = 7.3
Belt weight (kg/ m ²)	4.5 kg/ m ²
Belt weight (lb/ ft ²)	0.92 lb/ ft ²
Minimum sprocket diameter (normal flex)*	80 mm/ 3¼"
Minimum sprocket diameter (back flex)*	100 mm/ 4"
Max pull force (kg/cm width)	3
Max pull force (lb/in. width)	16.8

Important Note: "LT" Low Temperature DualDrive™ belts can only be driven with Volta sprockets.

Pulley Guidelines & Fabrication Options

Table 2.4

Belt Type		FMB-3 DD LT			
MPD Base Belt		80mm		3¼"	
Minimum Sprocket Diameter for V-Cleat (working temp. range -20°C to 35°C (-4°F to 95°F))					
Electrode		120mm		4.72"	
VLC / VLB 10		130mm		5.12"	
VLC / VLB 13		140mm		5.51"	
VLC / VLB 17		155mm		6.10"	
Minimum Sprocket Diameter for Flat High Frequency Welded Flights					
App. Temperature		Temp ≥ 0° C	Temp ≥ 32° F	Temp < 0° C	Temp < 32° F
Flight 3 - 5 mm		101mm	3.97"	151mm	5.94"
Flight 6 - 8 mm		128mm	5.04"	180mm	7.09"
Minimum Sprocket Diameter for Based Sidewalls (working temp. range -20°C to 35°C (-4°F to 95°F))					
SW-20		130mm		5.12"	
SW-30		130mm		5.12"	
SW-40		130mm		5.12"	
SW-50		130mm		5.12"	
SW-60		130mm		5.12"	
SW-80		155mm		6.10"	
SW-100		210mm		8.27"	
Minimum Sprocket Diameter for Baseless Sidewalls					
		Normal Flex		Back Flex	
B-SW 30mm/ 1"	1.6mm Thick	80mm	3.15"	110mm	4.33"
B-SW 40 mm/ 1.5"		90mm	3.54"	120mm	4.72"
B-SW 50 mm/ 2"		100mm	3.94"	150mm	5.90"
B-SW 60 mm/ 2.5"		110mm	4.33"	180mm	7.10"
B-SW 80 mm/ 3"		130mm	5.12"	230mm	9.05"
B-SW 100 mm/ 4"		160mm	6.30"	300mm	11.81"
B-SW 130 mm/ 5"	2mm Thick	210mm	8.27"	400mm	15.75"
B-SW 150 mm/ 6"		250mm	9.84"	450mm	17.72"

Note: All inch sizes have been converted from metric sizes.

Guidelines and Suggested Materials for the Fabrication of FMB-3 DD LT belt

- ➔ **Sidewalls:** It is possible to weld Sidewalls from L material to the LT belts.
- ➔ **Flights:** It is recommended using LT material as preferred Flights material. MB material is also acceptable but in this case you should make sure that the temperature of your application does not exceed the regular MB LT materials limit. Flights can be welded on top of a tooth but they must not exceed the width of the tooth or between teeth, but not in the area where sprocket teeth make contact with the belt when driving it.
- ➔ **Electrodes:** We do not recommend using electrodes for welding flights on these belts. The entire belt area around the welded electrode becomes rigid and flexibility is lost.
- ➔ **HF Welding:** We only approve HF welding of flights on these LT belts.
- ➔ **Endless Making:** We suggest joining LT belts with a Butt weld using the FBW Tool.

Volta 'MD' Metal Detectable Material DualDrive™ Belts

- ➔ **Material:** Volta MB MD, Blue
- ➔ **Shore Hardness:** 53D
- ➔ **Temperature Range :** -20° C to 60° C / -5° F to 140° F
- ➔ **Coefficient of Friction:** Steel: 0.5 /Stainless Steel: 0.5 /UHMW: 0.28
- ➔ **Certification:** FDA Approved

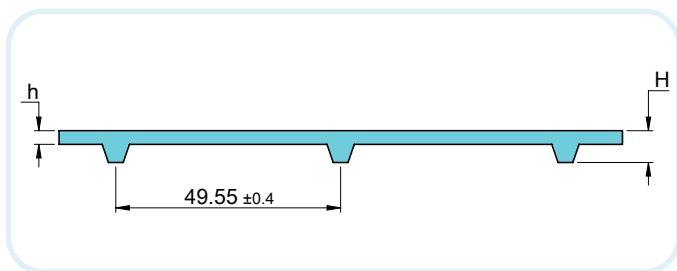

***h**= Belt Thickness, **H** = Belt Thickness + 4.3mm
Pitch Between Teeth : 49.55 ± 0.4
Standard Belt Width: 1524mm / 60"

Table 2.5

Product	FMB-3 DD MD
Belt Thickness	3
Belt weight (kg/ m ²) Add for each row of teeth	4.8
Belt weight (lb/ ft ²) Add for each row of teeth	0.98
Minimum pulley diameter (normal flex)*	100 mm/ 4"
Minimum pulley diameter (back flex)*	110 mm/ 4.33"
Max pull force (kg/ cm width)	6
Max pull force (lb/ in. width)	33.60

Note: *All inch sizes have been converted from metric sizes.

Pulley Guidelines & Fabrication Options

Table 2.6





Belt Type	FMB-3-DD MD				
MPD Base Belt	100mm		4"		
Minimum Pulley Diameter for V-Flights					
Electrode	135mm		5.31"		
VLB 10	145mm		5.70"		
VLB 13	155mm		6.10"		
VLB 17	170mm		6.70"		
Minimum Pulley Diameter for Electrode Welded Flat Flights					
Single Electrode 7	140mm		5.51"		
Single Electrode 9	150mm		6.10"		
Double Electrode 7	180mm		7.08"		
Double Electrode 9	NR				
Minimum Pulley Diameter for High Frequency Welded Flat Flights					
App. Temperature	Temp ≥ 0° C	Temp ≥ 32° F	Temp < 0° C	Temp < 32° F	
Flight 3 - 5 mm	116mm	4.56"	165mm	6.50"	
Flight 6 - 8 mm	143mm	5.62"	195mm	7.67"	
Minimum Pulley Diameter for Based Sidewalls-Normal Flex					
SW-20	130mm		5.12"		
SW-30	130mm		5.12"		
SW-40	130mm		5.12"		
SW-50	130mm		5.12"		
SW-60	130mm		5.12"		
SW-80	155mm		6.10"		
SW-100	210mm		8.27"		
Minimum Pulley Diameter for Baseless Sidewalls					
		Normal Flex		Back Flex	
B-SW 30mm/ 1"	1.6mm Thick	110mm	4.33"	120mm	4.72"
B-SW 40 mm/ 1.5"		110mm	4.33"	120mm	4.72"
B-SW 50 mm/ 2"		110mm	4.33"	150mm	5.90"
B-SW 60 mm/ 2.5"		110mm	4.33"	180mm	7.10"
B-SW 80 mm/ 3"		130mm	5.12"	230mm	9.05"
B-SW 100 mm/ 4"		160mm	6.30"	300mm	11.81"
B-SW 130 mm/ 5"	2mm Thick	210mm	8.27"	400mm	15.75"
B-SW 150 mm/ 6"		250mm	9.84"	450mm	17.72"
Minimum Pulley Diameter for Two Top Guides-Contact your local distributor					

Note: NR - Not Recommended.

All inch sizes have been converted from metric sizes.

 **Disclaimer:** Volta Belting Ltd. recommends testing all the products in your environment to ascertain suitability. The information is supplied in good faith without warranty.

Guidelines and Suggested Materials for the Fabrication of FMB-3 DD MD belt

-  **Electrode Welded Flights:** We recommend welding the flights above the teeth location and flight thickness should not exceed the tooth base width.
-  **Sidewalls:** must be positioned with a minimum gap of 100mm from the belt teeth.
-  **Flights:** should be welded between the teeth as indicated in the sketch. Can be welded over the teeth if they do not exceed the tooth width. Must not be welded next to the teeth as indicated in the sketch.
-  **Pulleys:** must be equal to, or larger than the minimum pulley specification.

Volta 'H' Material DualDrive™ Belts

- ➔ **Material:** Volta HW, Beige / Volta HB, Blue
- ➔ **Shore Hardness:** 55D
- ➔ **Temperature Range :** -20° C to 75° C / -5° F to 170° F
- ➔ **Coefficient of Friction:** Steel: 0.4 / Stainless Steel: 0.4 / UHMW: 0.2
- ➔ **Certification:** FDA/ USDA/ USDA Dairy/ EU Approved

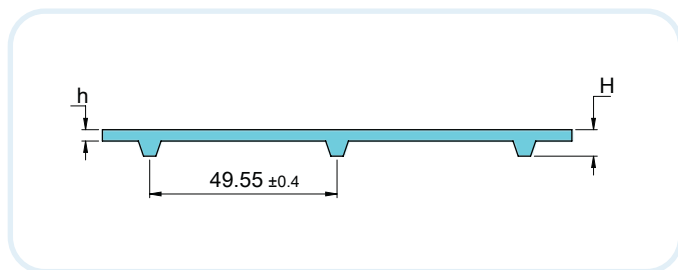

***h**= Belt Thickness, **H** = Belt Thickness + 4.3mm
Pitch Between Teeth : 49.55 ± 0.4mm
Standard Belt Width: 1524mm / 60"

Table 2.7

Product	FHB-3 DD	FHW-3 DD
Belt Thickness*	h = 3, H = 7.3	
Belt weight (kg/ m ²)	4.5 kg/ m ²	
Belt weight (lb/ ft ²)	0.92 lb/ ft ²	
Minimum sprocket diameter (normal flex)	100 mm/ 4"	
Minimum sprocket diameter (back flex)	150 mm/ 6"	
Max pull force (kg/cm width)	7	
Max pull force (lb/in. width)	39.2	

Important Note: 'H' Material DualDrive™ belts can only be driven with Volta sprockets.

Pulley Guidelines & Fabrication Options

Table 2.8

Belt Type	FHW-3 DD / FHB-3 DD	
MPD Base Belt	100mm	4"
Minimum Sprocket Diameter for V-Flights		
Electrode	132mm	5.20"
VW / VWB 10	157mm	6.18"
VW / VWB 13	177mm	6.97"
VW / VWB 17	217mm	8.54"
Minimum Sprocket Diameter for Flat Electrode Welded Flights		
Single Electrode 7	157mm	6.18"
Single Electrode 9	177mm	6.97"
Double Electrode 7	192mm	7.56"
Double Electrode 9	NR	

Note: NR - Not Recommended.

- ➔ **Flights:** Can be welded on top of a tooth but they must not exceed the width of the tooth. Alternatively, can be welded proximate to the drive teeth where the sprocket teeth make contact with the belt.
- ➔ When choosing the sprocket size, it must be equal to or larger than the minimum pulley required.

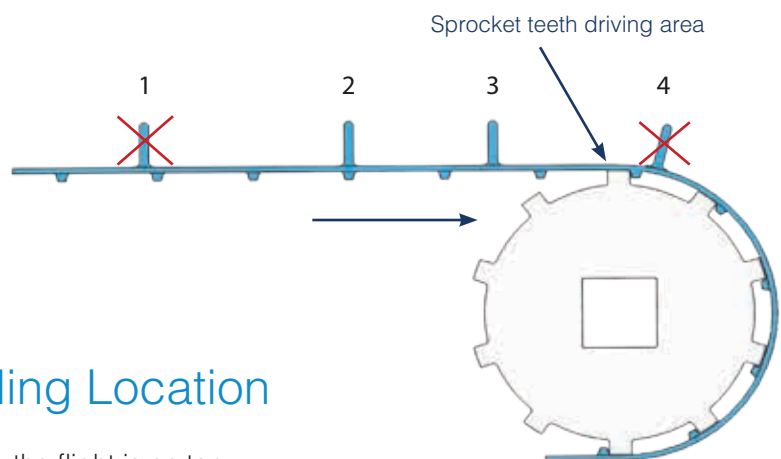

Recommended Flight Welding Location

- * Locations 1 & 4 are not recommended because the flight is on top of the sprocket teeth driving area.
- * Locations 2 & 3 are recommended.

Note: In location 2, it is essential that the cleat and weld widths do not exceed the width of the belt tooth.

3. Accessories

Volta Belting provides all the accessories required to operate the DualDrive™ belt.

Sprockets

Volta Provides two types of Sprockets:

UHMW Sprockets:

- Ensures durability in high friction applications and long life.
- Easy to clean.

Molded Sprockets* made of Acetal:

- Available in 8T and 10T dimensions.
- Suits both to 40mm and 1.5" square bore shaft.
- Easy to clean.

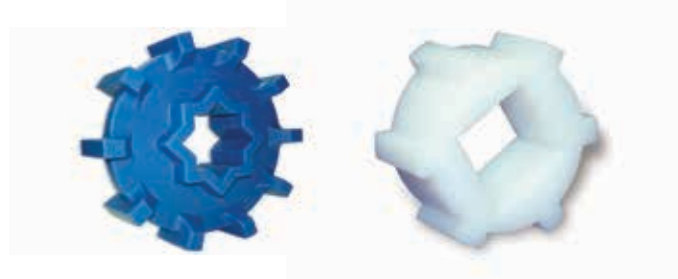

DualDrive™ Sprocket Types

Number of Teeth	Sprocket Outer Diameter		Sprocket Pitch Diameter			
	3mm & 4mm Thick Belts		3mm Thick Belts		4mm Thick Belts	
	mm	inch	mm	inch	mm	inch
6	93.4	3.67	96.4	3.79	97.4	3.83
8	125.6	4.94	128.6	5.06	129.6	5.10
10	157.7	6.20	160.7	6.32	161.7	6.36
12	189.9	7.47	192.9	7.59	193.9	7.63

- ➔ Standard Drive & Tail Pulley Width = 38⁺¹⁰ mm / 1½^{+3/8}"
- ➔ Standard Square Bore Dimensions = 40mm / 1½"
- ➔ Non-Standard Round Bores are available upon request.

- ➔ Non-Standard Square Bore Dimensions, available upon request:
 - 25mm / 1"; • 50mm / 2"; • 2½"

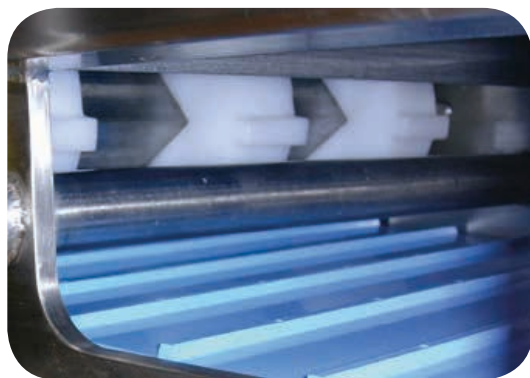

Sprocket Spacing

- ➔ Distance between sprocket centers should be between 4" and 6" (100mm to 150mm), according to the belt pull force.
- ➔ If the applied pull force will be higher than 50% of the maximum allowed pull force, then the distance between sprockets should be 4" (100mm), not more.
- ➔ Make sure that there is no depression of the belt between sprockets.
- ➔ If depression occurs between sprockets, additional sprockets should be fitted.
- ➔ Sprocket location should be in line with conveyor bed strips.

Sprocket Bore Description

The DualDrive™ sprockets are available in two standard square bore dimensions 1.5" & 40 mm. The 1.5" square bore dimension is also available with round corners. The round corner bore is designed to provide a channel for water to carry debris away during washdown.

Pulley bore dimensions should be chosen according to the load on the shaft to avoid shaft deflection and to transmit the required torque.

Volta supplies other bore dimensions according to your requirements (25 mm, 50 mm, 1", 2", 2.5"). Please contact your local Volta distributor for availability.

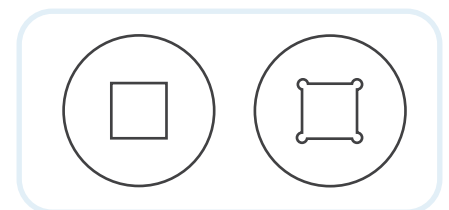

Standard bore Round Corner bore

Pulley bore patterns

Securing DualDrive™ Sprockets: Locking Collars

Standard Metal Locking Collar is made of two parts of stainless steel spring wire with locking bolts. This system can be assembled without dismantling the shaft and can be used with all sprocket types on 1.5 inch / 40mm square shaft.



Square Metal Locking Collar

Square Plastic Locking Collar (UHMW) is made of two plastic parts locked with two bolts. Can be assembled without dismantling the shaft. It can be used with sprockets that have 10 or more teeth and are available in 1.5in/ 40mm. Can be ordered with round corners. Locking Collar face width = 20mm.



Square Plastic (UHMW) Locking Collar

Round Plastic Locking Collar (UHMW) is suitable for 8 teeth sprockets, and larger. The shaft must be dismantled in order to assemble this locking collar. Can be ordered in 1.5in/40mm and also with round corners for 1.5 in. shaft. Locking Collar face width = 20mm.



Round Plastic (UHMW) Locking Collar

Additional Options for Securing DualDrive™ Sprockets

Volta offers three options for those customers who prefer to use a different method of securing the sprockets to the shaft. We recommend checking with your engineering department regarding the effects this will have on your conveyor shafts. Volta does not supply materials for this procedure nor is responsible for damage or weakening of the shaft when using one of these options.

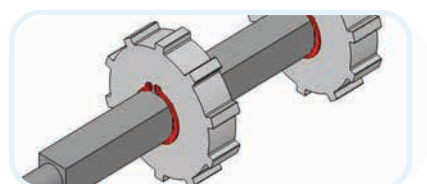

1. Use a “C” ring on the shaft on either end of the sprocket. Machine a groove suitable for the thickness of the “C” ring you are using. This method of securing the sprockets is standard with modular belting.

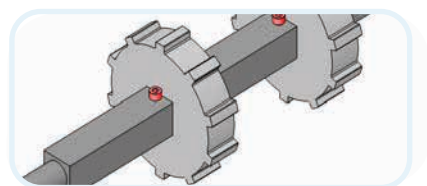

2. Drill and thread a hole at either end of the sprocket. Mount an Allen screw in each hole to secure the sprocket.

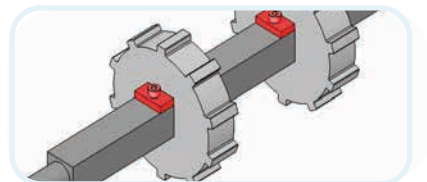

3. Mount a small piece of flat metal on either end of the sprocket. Drill and thread a hole in the shaft and mount an Allen screw to secure the metal plates.

Motorized Pulley

We cooperate with several of the best known motorized pulley manufacturers to develop drum motors fitted with pulleys and teeth suitable to the DualDrive™ conveyor belt. Please contact your local Volta Belting distributor or your local Motorized Drum supplier for further information.

4. Conveyor Construction

Classic Conveyor Construction

The classic conveyor construction consists of the following parts:

- Volta Drive Sprockets mounted on the Drive end.
- Volta Drive Sprockets or other smooth pulleys mounted on the Tail end.
- Slidebed made of UHMW strips.
- Take-up Device (Tensioner).
- Return Rollers.
- Snub Rollers.
- Many conveyors are constructed especially to allow quick removal of the endless welded belt.
- In order to minimize friction we highly recommend using UHMW at all contact points.



If you are required to use stainless steel, please remember that the relative high friction between the two surfaces will affect both performance and tracking of the belt.

Please contact your nearest Volta representative for construction recommendations.

Conveyor Construction Guidelines

When placing the DualDrive™ Sprocket onto your shaft make sure that all of the sprockets' teeth are arranged in a position matching each other and properly aligned along the shaft.

Note: It is important to support the DualDrive material properly. Many conveyors originally built to run modular belts have fewer supports because the modular product is much more laterally rigid. Sufficient support of Dual Drive is essential in order to avoid stretching and wear.

Drawing 1:

W type 100mm – 150mm / 4" – 6" according to the belt pull force Up to 50% of the maximum allowed pull force **W** can be 150mm / 6" Over 50% of the maximum allowed pull force **W** = 100mm / 4"

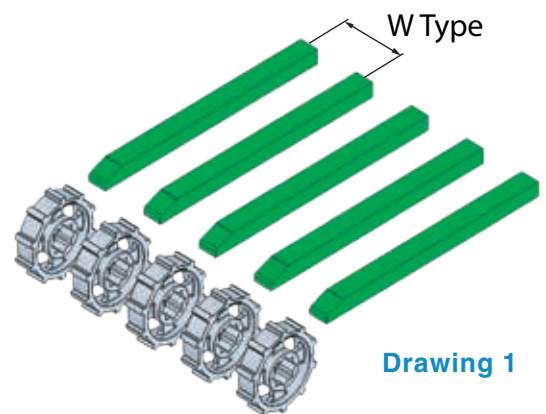

Drawing 1

Drawing 2:

A = Half of sprocket diameter - 4mm.

B = The distance of the front edge of the slide strip from the pulley depends on the cross section of the slide strip and the slide strip supports. **B** should be kept to a minimum possible distance while allowing at least 20mm for dimension 'x'.

C = Distance between Slide Bed Surface and Return Bed Surface assuring a 180° wrap of the belt around the belt and sprocket.

For 3mm belt **C** = Pulley diameter + 1mm.

For 4mm belt **C** = Pulley diameter.

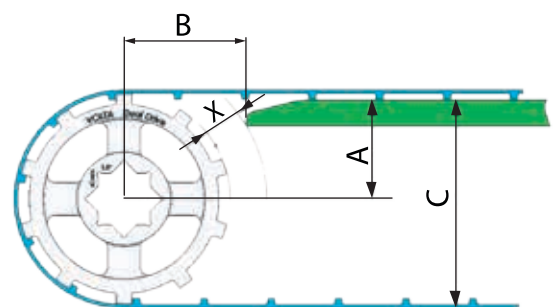

Drawing 2

Drawing 3:

F = between 25mm - 50mm / 1" - 2"

G = Maximum distance between the belt edge and strip: 50mm / 2"

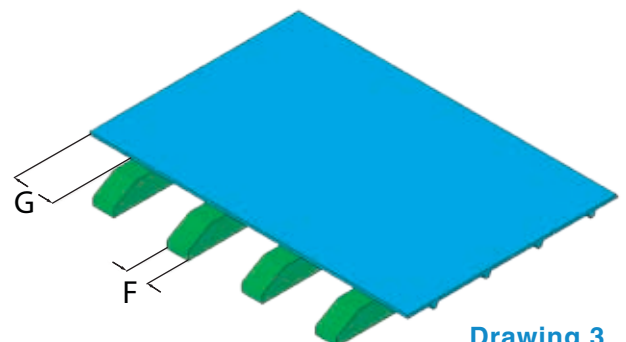

Drawing 3

Take-up Device (Tensioner)

Most DualDrive applications require no pretensioning at all. In certain special applications and heavy load applications you may need to pre-tension the belt slightly (up to 0.5%).

The take-up device (tensioner) serves 2 functions. The first is to facilitate the splicing and mounting of the belt and the second is to make cleaning of the belt easier. Opening the quick release take-up (tensioner) device provides slack between the pulleys, making cleaning of the belt underside more efficient while ensuring that the belt is returned to the exact same pre-tensioning after cleaning. Belt tensioning length and structure depends on a number of factors, conveyor length, cleaning method and conveyor structure. Generally minimum take-up of 5-8" (130 – 200mm) is required.

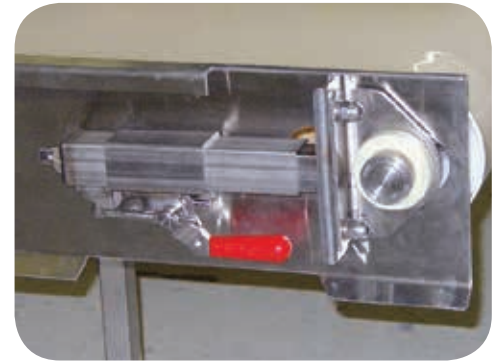

Return-Ways

Return-ways can be created in the form of rollers, continuous rails or shoes. The return-ways should support the belt and enable the proper working of the belt.

- When using continuous rails, the lateral centre distance between each rail should not exceed 12" / 305mm and the outer edges should not be indented by more than 2" / 50mm. In order to minimize the friction UHMW material is highly recommended.
- When using rollers the maximum recommended distance between the rollers is 5ft./1.5m. The rollers can be designed with flanges on edges to guide the belt.

Special care should be taken when working with no pretension at all.

➔ Channeling the belt sag by correct spacing of return rollers

The belt can be allowed to sag between the return rollers. However, it is important to avoid slack around the drive sprocket which can cause the belt teeth to disengage from the drive sprocket during operation. The distance between the return rollers should prevent the belt weight from slacking around the drive sprockets. Return support rollers can be engineered to allow for belt accumulation to occur in a specific location.

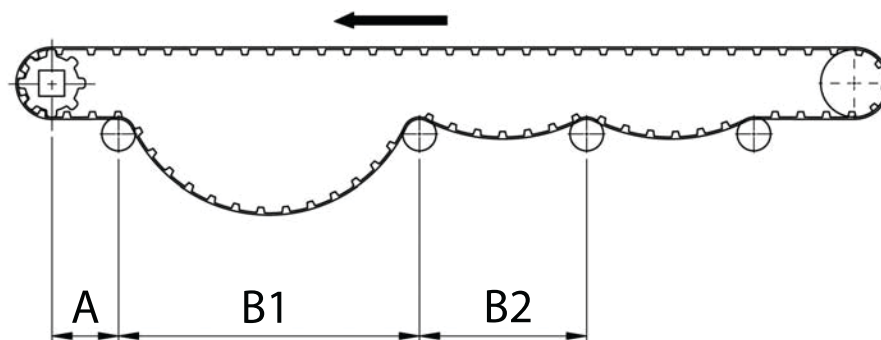

- A larger spacing is used for 'B1' in order to allow the belt weight to accommodate the belt sagging into this area and to prevent sagging and disengagement around the drive pulley.
- 'B2' shows the regular spacing.
- The space "A" is much smaller than the regular spaces between the return rollers.

➔ Return-ways with flights

If flights are applied to the Dual Drive™ material, it is suggested that continuous rails are used. When flights are indented from the belt edge, the return support rails should be positioned to support the belt 1/4"/6mm from the flights. An additional center rail support is recommended for belts 24"/61cm and wider. In order to minimize friction at contact points, UHMW material is highly recommended.

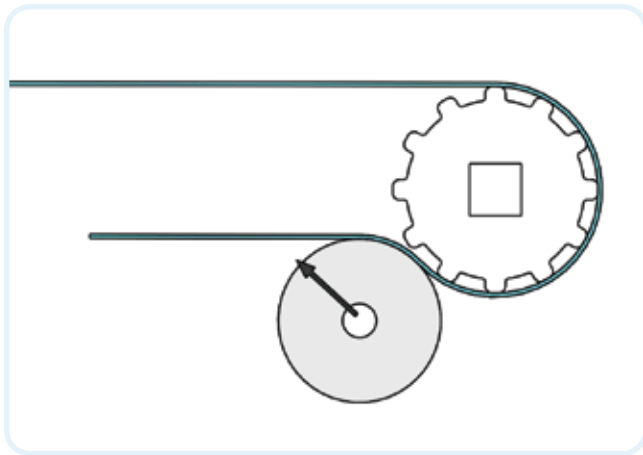

Snub Rollers

Snub Rollers are widely used to increase the arc of contact on the drive pulley and increase belt tension, thereby eliminating slack which can cause the belt to jump. The belt may sag, and return rollers can be positioned at equal distances to carry the sag. Safety precautions must be taken to prevent access to the snub roller working area.

Containment of DualDrive™ Belting

DualDrive™ belt is not tracked like standard flat belting that requires tensioning or steering of the rollers or like modular belts where the sprockets track the belt.

As DualDrive™ belts run with no pre-tension it is possible to contain the belt rather than track or guide it.

The 2 steps required to achieve containment are:

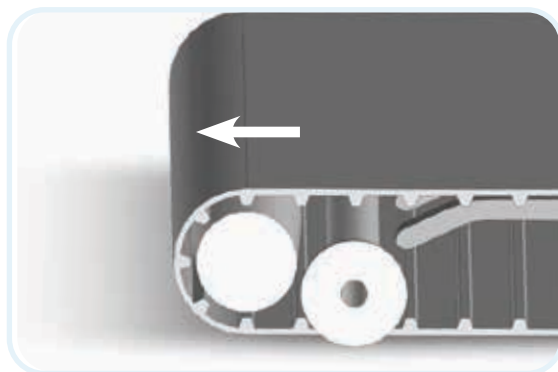

1. Flanged rollers on the return way.

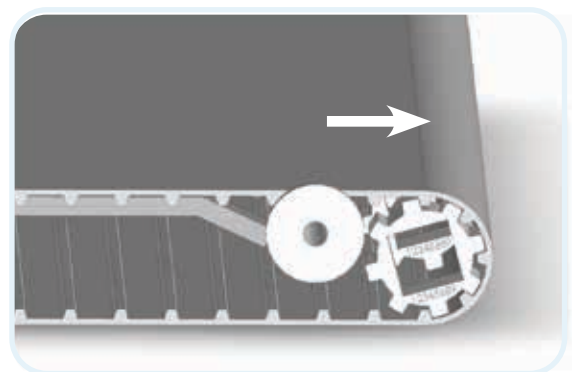

2. Flanged rollers before the drive side

- ➔ The roller and flanges should be wider than the belt and have clearance of 0.15–0.2" / 4-5mm each side of the belt.

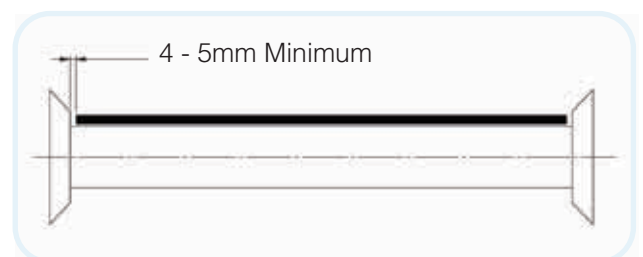

Another option is to use Containment blocks (side shoes) which are used on the frame of the conveyor. In order to minimize friction it is essential to use UHMW in these contact points.

“Z” or Swan-neck Conveyor Construction

The “Z” or Swan-neck conveyor is in common use for lifting product. DualDrive™ is ideally suited to this type of conveyor for several reasons:

- The DualDrive™ material is relatively stiff all across the belt and will not bend in the middle at the transition from a horizontal to an angled position.
- The DualDrive™ operates without tension; therefore, the problem of holding the belt in place is reduced and can be achieved easily.

The position change (from horizontal to angle) can be made as for regular belts by using a roller or a set of small rollers (see drawing below).

1. Tail Pulley.
2. Roller Set: Transition Horizontal to Incline.
3. Incline UHMW Slide Bed.
4. Top Roller: Transition Incline to Horizontal.*
5. Drive Sprocket.
6. Roller Set: Return transition horizontal to decline.
7. Return Support Roller.
8. Bottom Roller: Return transition decline to horizontal.
9. Take-up Device (Tensioner) for tail Sprocket.

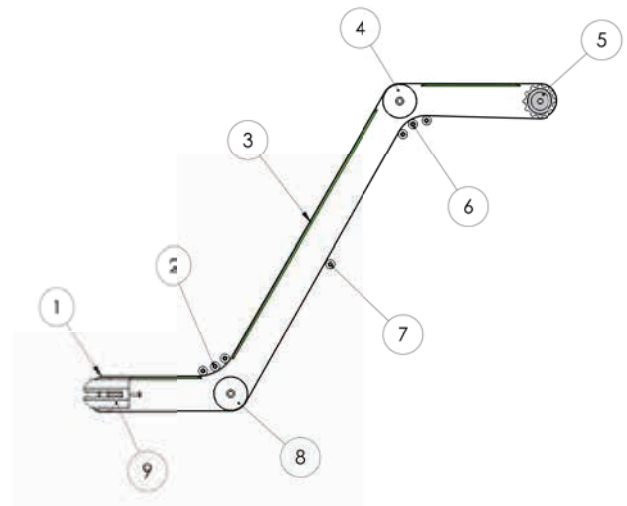

Note: * Smooth Rollers can be used in this position as long as the arc of contact between the smooth roller and the DualDrive™ belt is at least 3 teeth. Special grooved sprockets for the teeth can also be used for this area. For additional information contact your local distributor.

The above drawing demonstrates typical Z-elevator conveyor construction showing the UHMW strip bed. In transition areas 2 + 4 – the belt rubs against the conveyors’ curved construction which creates a high strain area. It is very important to use rollers at these two transition points to minimize the strain and friction.

There are 3 typical options for the transition areas

Shoe - this option is acceptable only when using H type belts and they must be made of UHMW.

Roller - one large roller.

Roller sets consisting of 3-4 rollers.

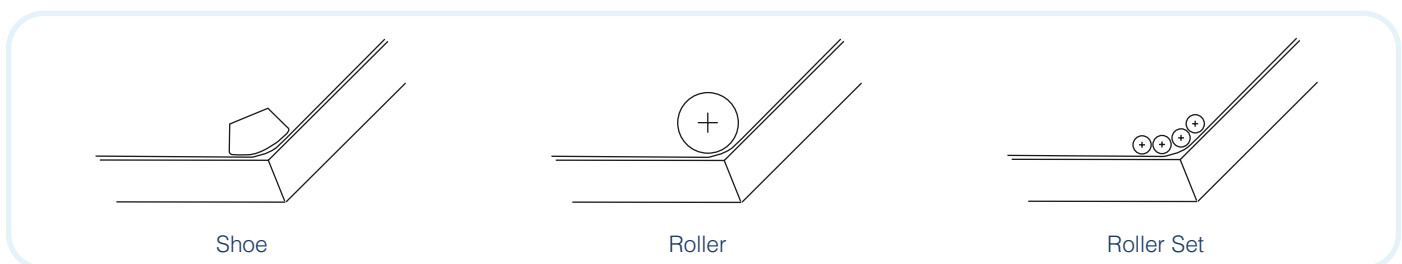

Swan-neck conveyor - transition rollers/ shoe (direction change) options

- The belt curve should be the maximum possible size and not less than the minimum pulley diameter of the belt + fabrications. In principle, the bigger the curve, the better. It is easiest to apply the roller set to larger curves.
- Do not use the shoe option with ‘M’ material belts, heavy loads or long conveyors. This type is least recommended.
- When using wide belts, it is very important to support the belt on the return side. Using flights may cause problems and a center gap in the flight may be necessary to enable proper belt support.

Center Drive Conveyor

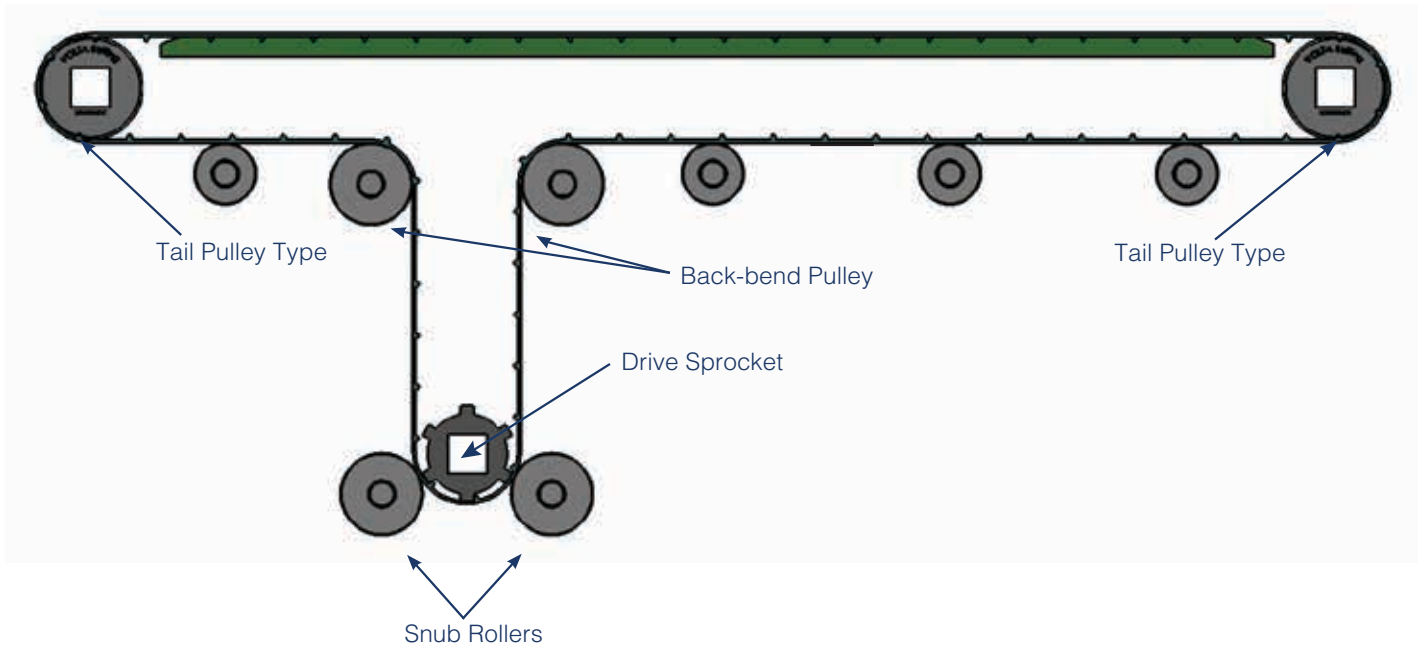

This conveyor is used in two typical applications:

- One option is when the drive sprocket is large, the tail sprocket can be much smaller within the limitations of the minimum sprocket diameter of the base belt making the conveyor most suitable for tight transition of products. Only the drive shaft should be fitted with sprocket and all other shafts should have smooth rollers.
- Another option is when the conveyor works in two directions. In this case you would need two snub rollers to ensure smooth operation. To prevent slippage and jumping the belt must be tensioned up to 0.5%. In most cases, snub rollers are placed both before and after the drive pulley, positioned tightly against the drive pulley on both sides. This ensures smooth operation when the belt is running in both directions.

Removing the Belt for Cleaning

There are a number of options in the conveyor construction that allow the belt to be removed from the conveyor without being opened.

These common features are:

- Take-up Device (Tensioner) - This device permits the release of belt tension without losing belt alignment (Page 14). In some conveyors telescopic supports are used. During normal operation of the conveyor, the supports are flush with the sides of the conveyor. During cleaning or maintenance, the supports are pulled out and are in a position to hold the conveyor belt during cleaning and maintenance (see the drawing below).
- The Hinge Lace or Metal Lace can be used to open the belt for cleaning and maintenance (Page 19).

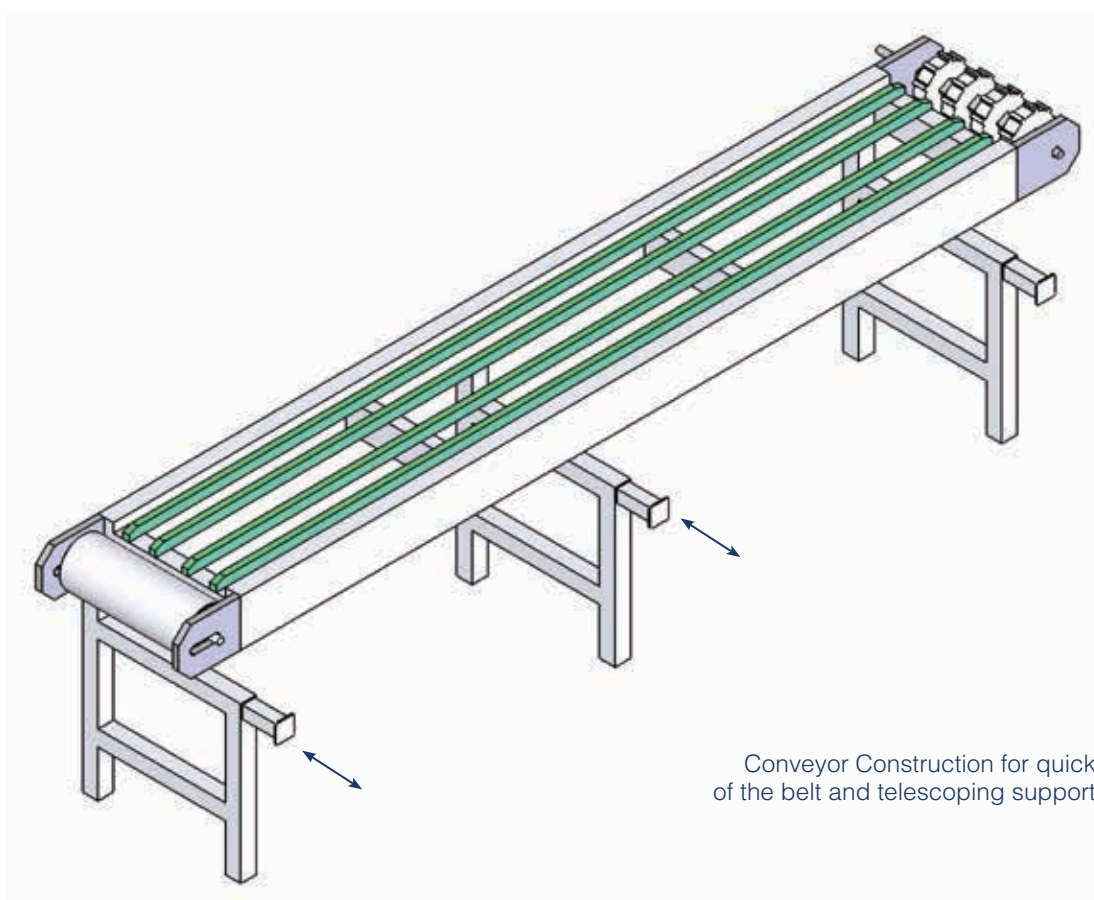

Conveyor Construction for quick dismounting of the belt and telescoping supports to hold the belt

5. Splicing the DualDrive™

The DualDrive™ conveyor belt is manufactured with a series of teeth as an integral part of the belt. These teeth are designed to mesh with the teeth on the DualDrive™ drive sprockets. To ensure efficient performance, it is necessary to maintain the spacing between the teeth in the region of the weld. We recommend using Volta Tools for this procedure. These tools are designed for use with all of our belts and materials. They are also designed to maintain the correct spacing between the teeth on the DualDrive™ belt.

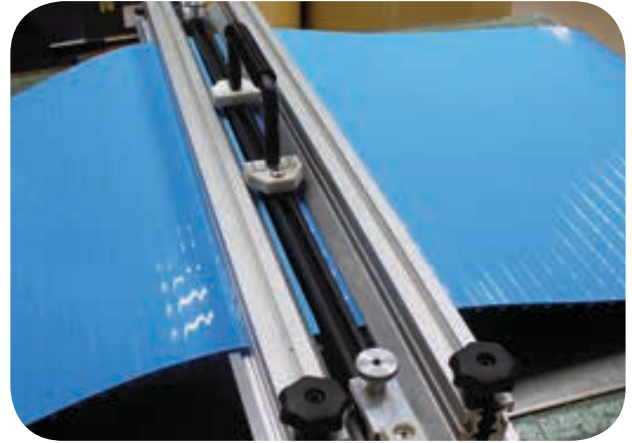

FBW Flat Butt Welding Tool

The FBW System was created to butt-weld flat belts making them endless. The FBW Welding System can be used for SuperDrive™, DualDrive™, DualDrive™ SP and special textured top flat belts. The FBW tool range offers maximum splicing width up to 2300mm.



Flat Butt Welding System for Positive Drive Belts (FBW PD)

FT - Electrode Welding Kit

For the FT Welding System extruded electrodes are used for endless splicing Volta flat belts and SuperDrive™, DualDrive™ and DualDrive™ SP. The FT Welding System uses a router to cut the angle on the belt edges and to trim the weld on completion. The weld is carried out by using a Leister Hot Air Gun and Volta electrodes. When joining up to 2mm thick belts, use the 7mm section electrode and for a belt thicker than 2mm, the 9mm section electrode is used. This tool is supplied with a built-in adaptor for welding SuperDrive™ belts. The FT tool range offers maximum splicing width of 1000mm and 1500mm.

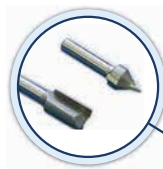

Flat Electrode Welding System

Plastic Hinge Lace

The Plastic Hinge Lace allows you to easily open the belt by taking the hinge pin out, clean or service the conveyor, reinstall the belt and close the lace with a new pin. The Plastic Hinge Lace is made of Volta homogeneous food approved materials and is compatible with Volta M family product belts. Volta belts are renowned for their homogeneous and hygienic characteristics and, therefore, they do not require opening and joining on a regular basis- unlike modular belts.



Closing belt with Universal Lace

Hinge Lace Benefits

Easy Open-Close Technique

The fastening structure allows you to easily open the Plastic Hinge Lace by removing the hinge pin from the lace. After setting up the belt on the conveyor, fasten the lace and secure it by inserting a new hinge pin into the slit and crimp up the pin ends.

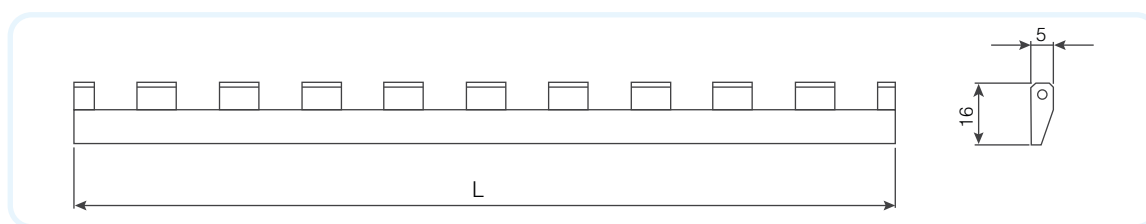

Reduced Maintenance Downtime

Since Volta belts are extremely hygienic, you don't have to regularly install and uninstall your belt for cleaning. In cases where belt dismantling is necessary, Universal Lace provides you with the best solution. This is because the Volta Universal Lace will not tear off from the belt, since it is welded onto your belt and is made of the same homogeneous material.

➔ We recommend using the Universal Lace only when absolutely necessary. Make sure that the conveyor pulleys fully support the entire face length of the belt or at least 80% of the face length. Note that the maximum allowed pull force for the lace (per cm/ in.) is lower than the allowed pull force of the belt (per cm/ in.). Therefore, check that the calculated pull force of your belt is lower than the maximum allowed pull force of the lace.

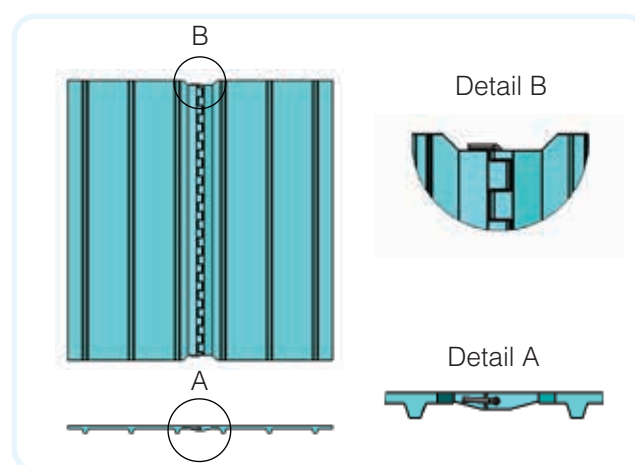

Plastic Hinge Lace Specifications

	Volta LMW-U	Volta LMB-U
Description	Flat toothed strip	Flat toothed strip
Material	Volta MW, beige	Volta MB, blue
Hardness	95A	95A
Working Temp Range	-20°C to 60°C/ -5°F to 140°F	-20°C to 60°C/ -5°F to 140°F
Dimensions	5 x 16 mm - 0.2 in x 0.63 in	5 x 16 mm - 0.2 in x 0.63 in
Max Length	3.05 m - 10 ft	3.05 m - 10 ft
Max Pull Force	3 kg/cm - 16.8 lb/in	3 kg/cm - 16.8 lb/in
Minimum Pulley Normal Flex with DD 3mm	80 mm/ 3 ¹ / ₈ in.	80 mm/ 3 ¹ / ₈ in.
Minimum Pulley Back Flex with DD 3mm	100 mm/ 4 in.	100 mm/ 4 in.
Hinge Pin	Nylo - Steel: 1.65mm/ 0.065"	
Certifications	FDA, USDA, USDA Dairy, EU Approved	

6. Belt Calculations

Pull Force Calculation Procedure

1. Net Pull Force F on the belt is calculated by the formula

$$F = f_s * (G_1 + G_2) \frac{X}{L} + f_R * G_2 * \frac{X}{L} + f_R * G_3 + C * G_1 * \frac{H}{L} + 0.25 * G_4$$

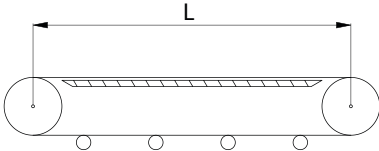
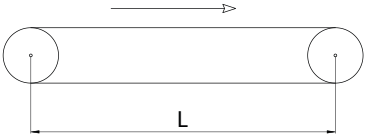
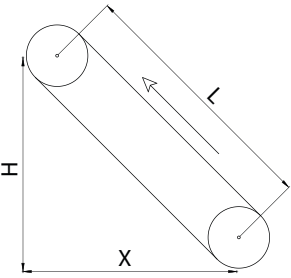
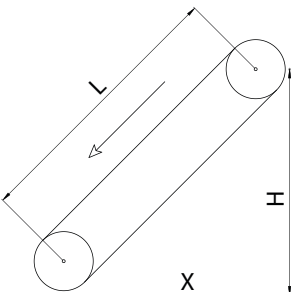
	<p>Conveyor with slide bed</p> 		
Return Bed	Rollers with Bearings $f_R = 0.03$	Rollers with Bushing $f_R = 0.1$	UHMW Sliders $f_R =$ refer to technical data sheet
Slide Bed	$f_s =$ refer to technical data sheet		
1. Horizontal transport	 <p>$C = 0; L = X; H = 0$</p>		
2. Incline	 <p>$C = 1$</p>		
3. Decline	 <p>$C = -1$</p>		

Symbols and Dimensions

f_R = Coefficient of friction of rollers (Bearings or Bushing) X = Horizontal distance of conveyor (m)/ (ft)
 f_s = Coefficient of friction of belt on slidebed G_1 = Maximum load on the conveyor (kg)/ (Lb)
 L = Conveyor length (m)/ (ft) G_2 = Belt weight (one direction) (kg)/ (Lb)
 H = Elevating height (m)/ (ft) G_3 = Weight of supporting rolls-upper and lower sections (kg)/(Lb)
 G_4 = Maximum accumulated weight (kg)/ (Lb)

* In case of Z Conveyor, the calculation is made up of two conveyors, one horizontal and one inclined. In order to find the total Pull Force, add the results of both calculations.

2. Calculate the allowed pull force (Fa) according to number of teeth in mesh

If the number of teeth in mesh is five or less, an adjustment must be made to the max pull force. Multiply the max pull force by K factor.

Table 5: K factor

Teeth in Mesh	K factor	Comment
6 or more	1	(180° Arc of contact at standard 150 mm/6" pulley)
5	0.8	
4	0.6	(180° Arc of contact at standard 100 mm/4" pulley)

$$F_a = F * K$$

Fa = Allowed Pull Force

3. Choose the belt width

Divide the calculated pull force by the belt width to get the pull force per unit width.

Check that the calculated pull force per unit width is less than the maximum.

Allow Pull Force according to number of teeth in mesh for the belt (Fa).

When using Lace, make sure that the Pull force on the belt is less than the allowed Pull force of the Lace.

Example:

An UHMW slide bed conveyor transporting meat packages horizontally.

1. Check if 18" belt (457 mm) is good for this application.

Given

	English-Imperial	Metric
Package weight:	30 (lbs)	13.6 (kg)
Maximum number of packages on belt:	30	30
Conveyor length:	50 (ft)	15.2 (m)
Return rollers weight (bushing):	10 (lbs)	4.5 (kg)
Number of return idlers:	6	6
Pulley diameter:	152 mm	6"
Number of teeth in mesh:	6	6

Procedure

Calculate the Pull Force:

Maximum load:	$G1 = 30 * 30 = 900$ (lbs)	$G1 = 30 * 13.6 = 408$ (kg)
Belt weight - one direction:	$G2 = 0.85 * (18/12) * 50 = 63.75$ lbs	$G2 = 4.15 * 0.457 * 15.2 = 28.82$ kg
Return idler weight:	$G3 = 6 * 10 = 60$ (lbs)	$G3 = 6 * 4.5 = 27$ (kg)
Accumulated weight :	$G4 = 0$	$G4 = 0$
	$F = fs * (G1 + G2) + fr * (G2 + G3) + 0.25 * G4$	
	$F = 0.28 * (900 + 63.7) + 0.1 * (63.7 + 60)$	$F = 0.28 * (408 + 28.8) + 0.1 * (28.8 + 27)$
	$F = 282.2$ (lbs)	$F = 127.9$ (kg)

2. Allow Pull Force according to number of teeth in mesh :

For 10 teeth sprockets at 180° Arc of contact - 5 teeth in mesh

$$K = 0.8 \text{ (5 teeth in mesh)}$$

3. Maximum allowed belt load:	$F_a = 0.8 * 33.6 = 26.8$ (lb/in)	$F_a = 0.8 * 6 = 4.8$ (kg/cm)
	$F(\text{max}) = 26.8 * 18 = 482.4$ (lbs)	$F(\text{max}) = 4.8 * 45 = 216$ (kg)
4. Belt width:	18" belt width (45 cm) is ok (the calculated Pull Force is less than the allowed Pull Force)	

7. Motor Capacity Calculation:

Calculation Procedure (for constant speed)

1. Calculation of the required torque for the drive pulley

Metric	English
$M = \frac{F \cdot 9.81 \cdot D_p}{1000 \cdot 2}$	$M = \frac{F \cdot D_p}{12 \cdot 2}$
M = torque [N · m]	M = torque [lb. · ft.]
F = calculated pull force [kg] - see section 6.1, pg. 24	F = calculated pull force [lb.] - see section 6.1, pg. 24
D _p = pulley pitch diameter [mm] - see page 10	D _p = pulley pitch diameter [in.] - see page 10

2. Calculation of drive pulley revolution [rpm]

$n = \frac{V \cdot 1000}{\pi \cdot D_p}$	$n = \frac{V \cdot 12}{\pi \cdot D_p}$
n = number of drive pulley revolution [rpm]	n = number of drive pulley revolution [rpm]
D _p = pulley pitch diameter [mm] - see page 10	D _p = pulley pitch diameter [in.] - see page 10
V = belt speed [m/min]	V = belt speed [ft./min]

3. Calculation of the motor capacity

$P = \frac{M \cdot n}{9550 \cdot \eta} \cdot k$	$P = \frac{M \cdot n}{5250 \cdot \eta} \cdot k$
P = power in [Kw] (0.746 Kw = 1 HP)	P = power in [HP] (1 HP = 0.746 Kw)
M = torque [N · m] (from step 1)	M = torque [lb.ft.] (from step 1)
n = number of drive pulley revolution [rpm] (from step 2)	n = number of drive pulley revolution [rpm] (from step 2)
η = efficiency of the drive transmission equipment (η < 1)	η = efficiency of the drive transmission equipment (η < 1)
It depends on the drive type and motor data provided by the manufacturer. In most cases it may vary from 0.6 to 0.85.	
k = correction/ safety coefficient (K > 1)	k = correction/ safety coefficient (K > 1)
Take into account working conditions according to the motor and drive gear data provided by the manufacturer.	

4. Choose a motor: the next size up

A series of horizontal lines for writing.

DualDrive™ Belts



Tail Roller

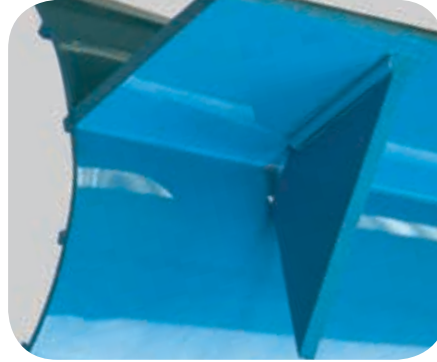

Gusset Cleat on DD



Return Side Support



Drive Sprocket



Modular Drive Sprocket



Volta Drive Sprocket



DD Meat Elevator



DD Meat Conveyor



Perforated DD Belt with Flights



VOLTA BELTING
Technology

Corporate Headquarters
Sales and Manufacturing
sales@voltabelting.com

USA
• Tel: +1 973 276 7905
• Fax: +1 973 276 7908
• Toll Free: 1-877-VOLTAUS

EUROPE
• Tel: +31-546-580166
• Fax: +31-546-579508

www.voltabelting.com

Volta Belting makes no warranty with respect to any of its products for a particular purpose.
See Volta General Terms and Conditions.

Copyright©2015 Volta Belting Technology Ltd.
CAT204EN00 - Ver.F- November 2015